



Magnetic Lock Wiring Instruction

Parameters

Model	Size (unit: mm)	Voltage	Current	Holding Force	Door	Feature	Weight
EL500-2	263Lx73Wx41H	12/24VDC	12V/ 450mA 24V/220mA	500kg (1200LBS)	Single Door	2wires with LED	4.5kg
EL500-5	263Lx73Wx41H	12/24VDC	12V/ 450mA 24V/220mA	500kg (1200LBS)	Single Door	5wires with LED Door Status	4.5kg
EL500-2T	263Lx73Wx41H	12/24VDC	12V/ 450mA 24V/220mA	500kg (1200LBS)	Single Door	5wires with LED 0-18s Time delay NO/NC/COM Output	4.5kg
EL500-M	220Lx63Wx36H	12/24VDC	12V/ 420mA 24V/210mA	500kg (1200LBS)	Single Door	5wires with LED Door Status	4.5kg

Diagram(unit: mm)

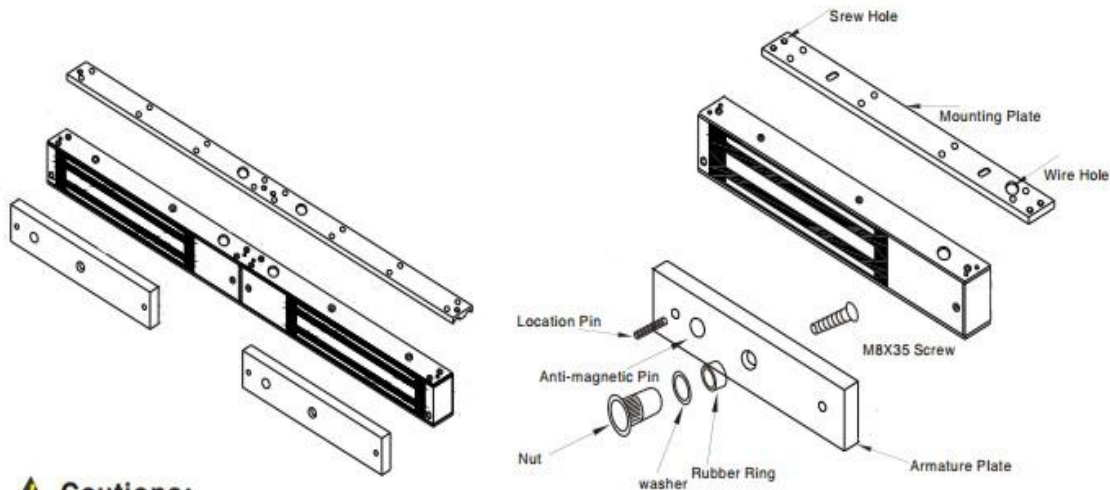

⚠ Cautions:

- A. The screw of armature plate should not be fixed too tight. Proper elasticity should be guaranteed for the rubber ring so that the armature plate can adjust itself to the appropriate position.
- B. Check the jumper's position before connecting. Figure out it represents 12VDC or 24VDC.

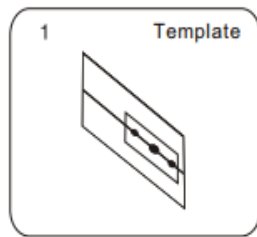
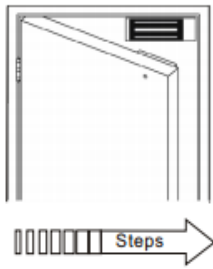

1 Template
Fold the plate to 90° .

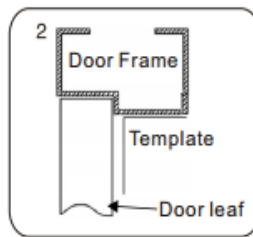

2 Door Frame
Template
Door leaf
Close the door first, then place the upper side of template on door frame, while adjust the left side next to the door leaf.

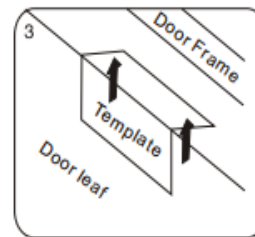

3 Door Frame
Template
Door leaf
Mark screw positions of armature plate and magnetic lock on door leaf and door frame respectively.

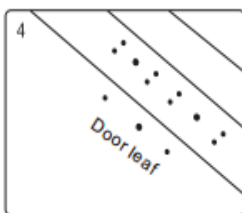

4 Door leaf
Drill holes based on the marked positions.

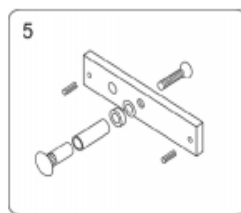

5
Make a combination based on the picture.

Hollow Metal Door Wooden Door Metal Surface Door



Drill a hole
Inside: Diameter is 8mm
Outside: Diameter is 16mm

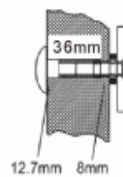

Drill a hole
Inside: Diameter is 8mm
Outside: Diameter is 12.7mm

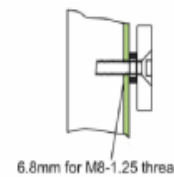

Inside: Drill a hole diameter is 8mm folding the plastic straight pin

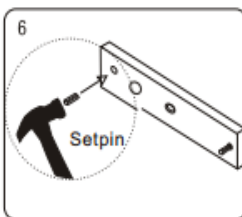

6 Setpin
Strike the pin into the armature plate slightly (to avoid movement).

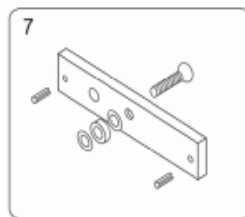

7
Make a combination based on the picture (add washer accordingly). The rubber ring must be added.

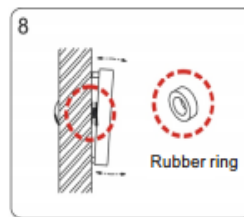

8 Rubber ring
Place the rubber ring between armature plate and door leaf.

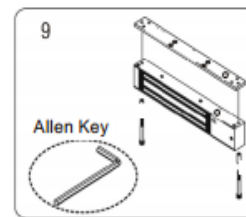

9 Allen Key
Use Allen key to remove the mounting plate from lock body.

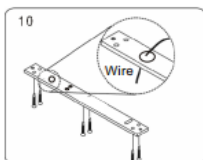

10 Wire
Fix the mounting plate on the door frame according to the holes drilled earlier.

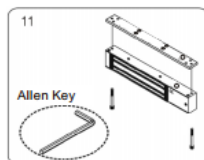

11 Allen Key
Use Allen key to screw the lock body on the mounting plate.

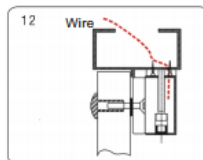

12 Wire
Close the door to test holding force. The angle between armature plate and magnetic lock can be adjusted by adding or reducing washers.

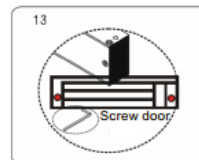

13 Screw door
After all the appropriate procedures, the holding force can be maximized. Finally, fix the tamper screw.

Bracket Installation

Different brackets are available according to different types of doors. For example, narrow door, frameless glass door and inward opening door.

L Bracket-For outward opening door
When the door frame thickness is less than 42mm, L bracket is needed.

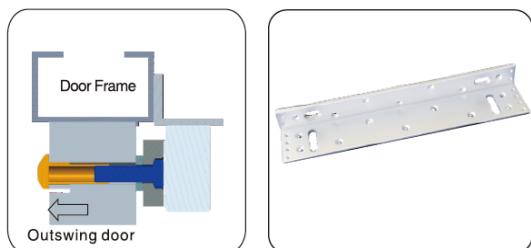

ZL Bracket-For inward opening door
For inward opening door, ZL bracket is needed.

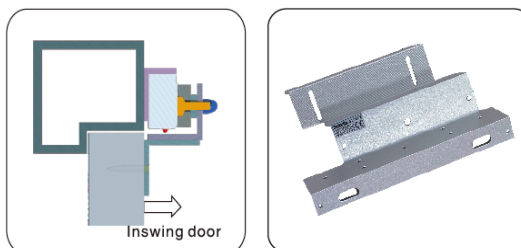

U Bracket

For the frameless glass door. U bracket is needed.

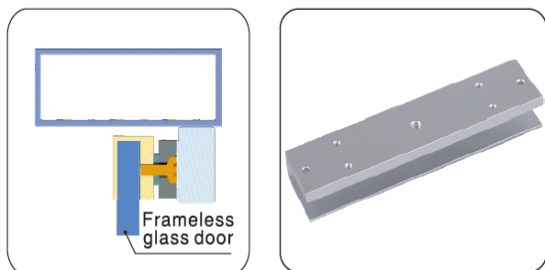

I Bracket for armature plate

When the door frame is too thick, I bracket is needed.

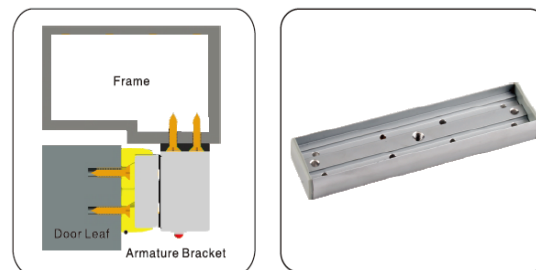

Wire Connection

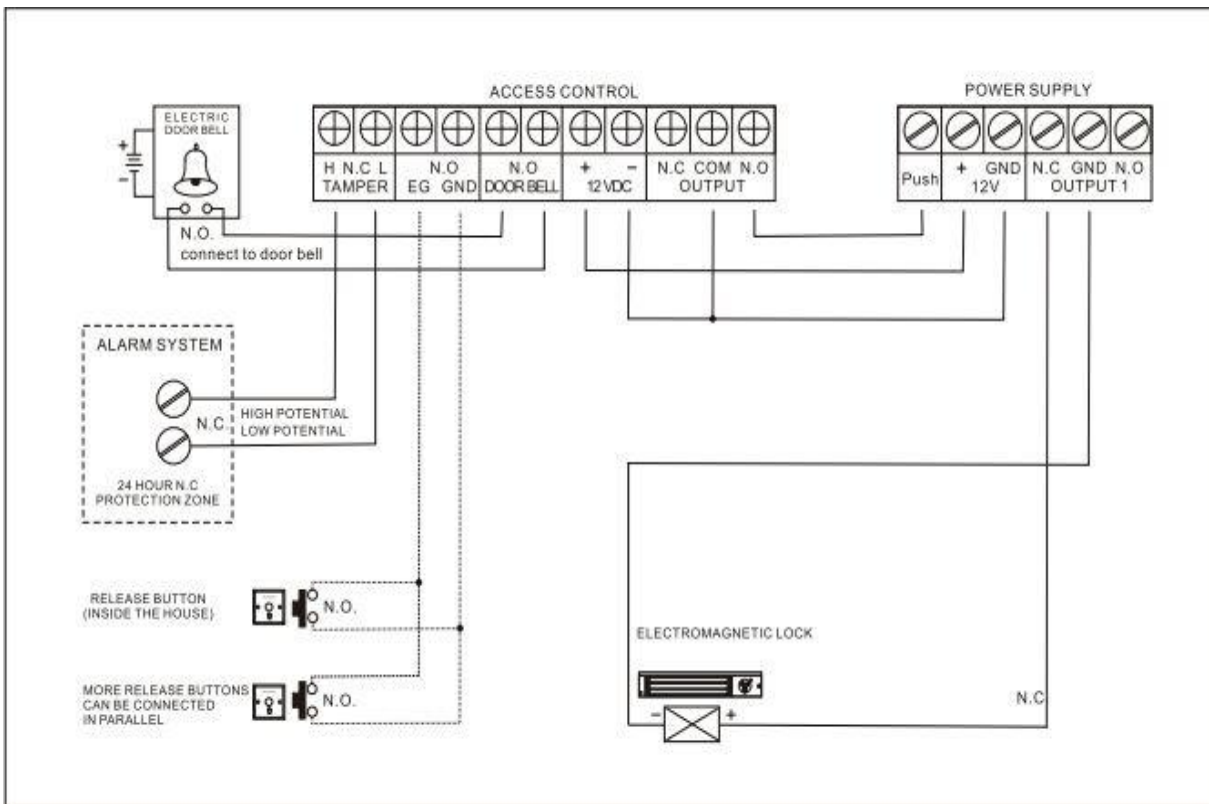

NOTES:

- Please read specification before installing magnetic lock
- A. Handle the equipment carefully. The holding force can be reduced by damaging the lock body or armature plate.
- B. The magnetic lock should be fixed tightly on the door frame and the armature plate on the door leaf. Kit provided allows the armature plate to pivot its center, thus compensating misalignment caused by other factors.
- C. Template can only be used with the door in normally closed circumstance.
- D. Please fix screws of magnetic lock firmly.
- E. Detect signal of door state: the limit of reed switch and dry contact is 0.5A/30VDC. Don't overload.