



# Magnetic Lock Wiring Instruction

## Parameters

Model	Size (unit: mm)	Voltage	Current	Holding Force	Door	Signal Output
EL180-2	170Lx39Wx21H	12/24VDC	12V/ 380mA 24V/190mA	180kg (350LBS)	Single Door	No
EL180D-2	340Lx39Wx21H	12/24VDC	12V/300mA 24V/150mA	180kgx2(350LBSx2)	Double Door	No

## Diagram(unit: mm)

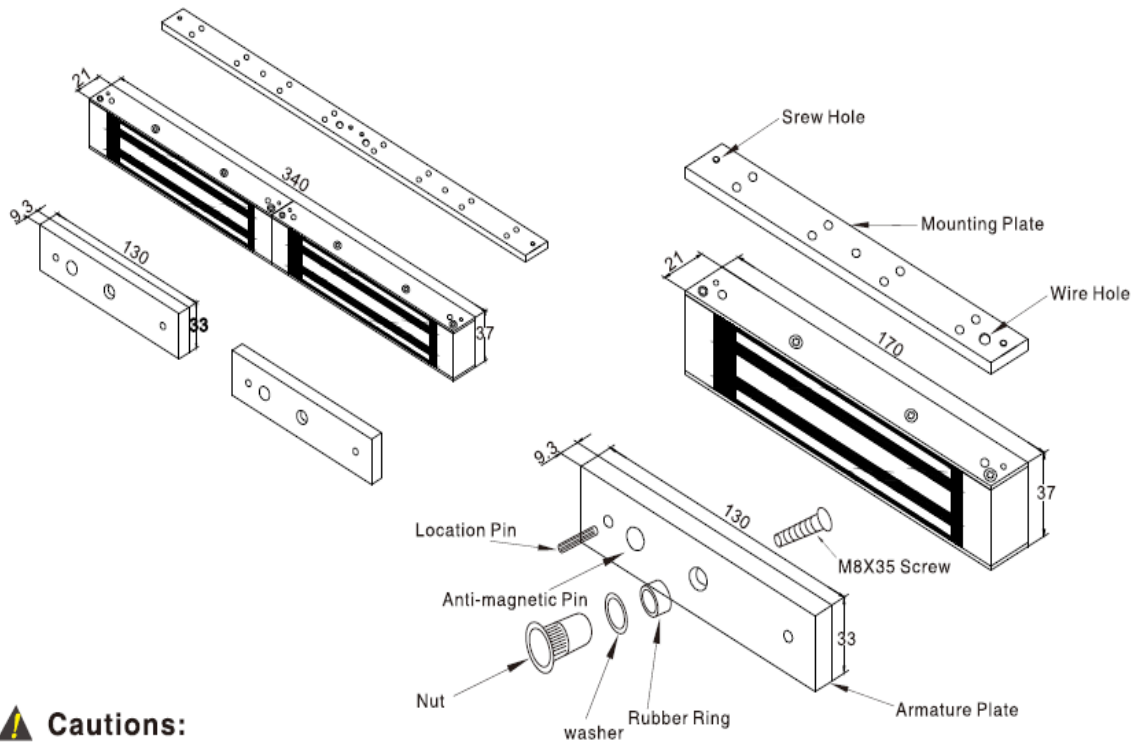

### ⚠ Cautions:

- The screw of armature plate should not be fixed too tight. Proper elasticity should be guaranteed for the rubber ring so that the armature plate can adjust itself to the appropriate position.
- Check the jumper's position before connecting. Figure out it represents 12VDC or 24VDC.

# Installation

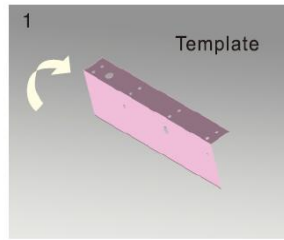

1 Fold the plate to 90° .

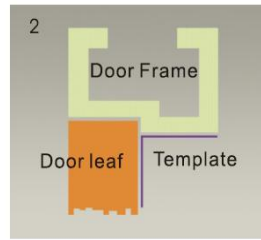

2 Close the door first, then place the upper side of template on door frame, while adjust the left side next to the door leaf.

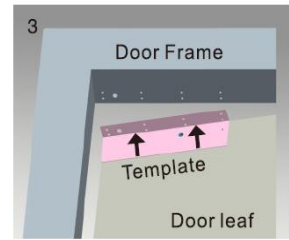

3 Mark screw positions of armature plate and magnetic lock on door leaf and door frame respectively.

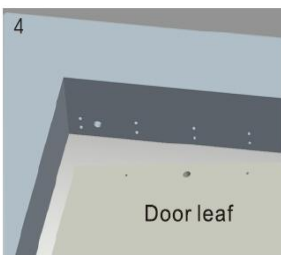

4 Drill holes based on the marked positions.

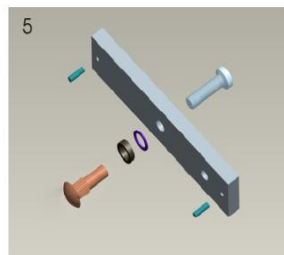

5 Make a combination based on the picture.

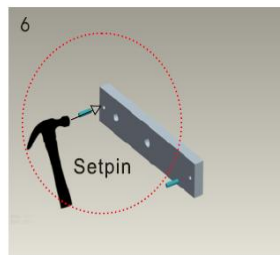

6 Strike the pin into the armature plate slightly (to avoid movement).

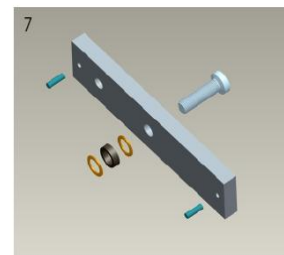

7 Make a combination based on the picture(add washer accordingly). The rubber ring must be added.

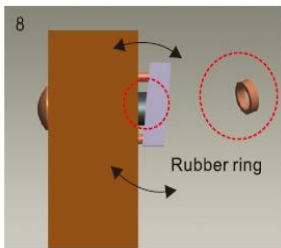

8 Place the rubber ring between armature plate and door leaf.

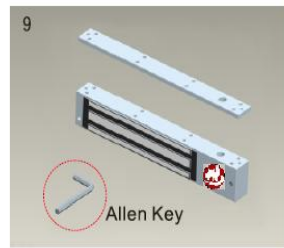

9 Use Allen key to remove the mounting plate from lock body.

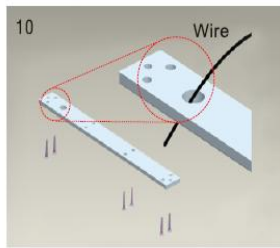

10 Fix the mounting plate on the door frame according to the holes drilled earlier.



11 Use Allen key to screw the lock body on the mounting plate.

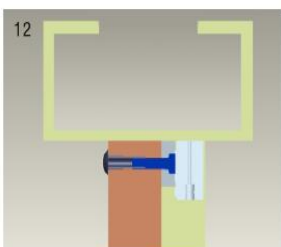

12 Close the door to test holding force. The angle between armature plate and magnetic lock can be adjusted by adding or reducing washers.



13 After all the appropriate procedures, the holding force can be maximized. Finally, fix the tamper screw.

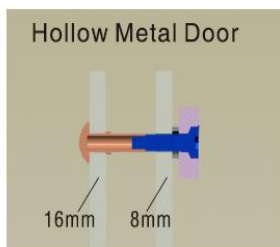

Hollow Metal Door  
Drill a hole  
Inside: Diameter is 8mm  
Outside: Diameter is 16mm

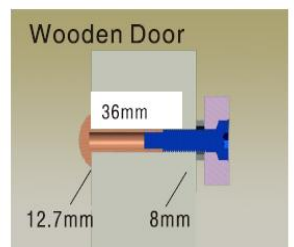

Wooden Door  
Drill a hole  
Inside: Diameter is 8mm  
Outside: Diameter is 12.7mm

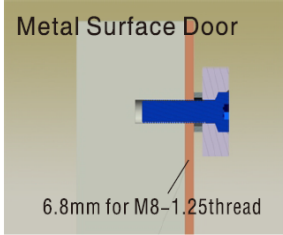

Inside: Drill a hole diameter is 8mm folding the plastic straight pin

**Notice:**  
 Thickness of Door Leaf:  
 350LBS: 44mm      600LBS: 50mm  
 800LBS: 48mm      1200LBS: 46mm

## Bracket Installation

Different brackets are available according to different types of doors. For example, narrow door, frameless glass door and inward opening door.

**L Bracket-For outward opening door**  
 When the door frame thickness is less than 42mm, L bracket is needed.

**ZL Bracket-For inward opening door**  
 For inward opening door, ZL bracket is needed.

**U Bracket**  
 For the frameless glass door. U bracket is needed.

**I Bracket for armature plate**  
 When the door frame is too thick, I bracket is needed.

## Installation Instruction

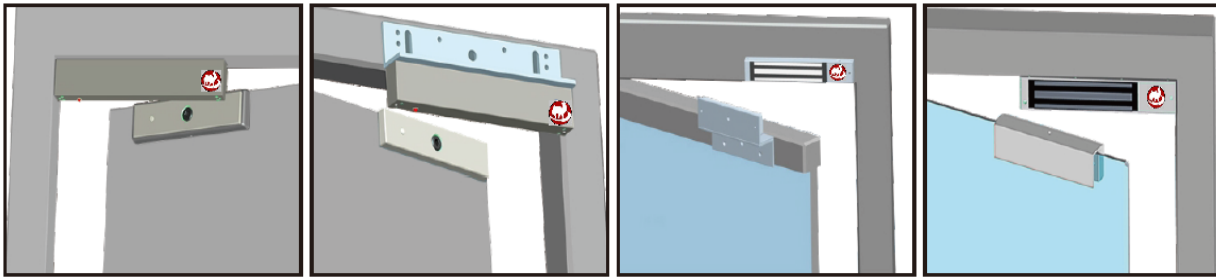

Demonstration of I Bracket Installation

Demonstration of L Bracket Installation

Demonstration of ZL Bracket Installation

Demonstration of UL Bracket Installation

## Circuit Board Diagram

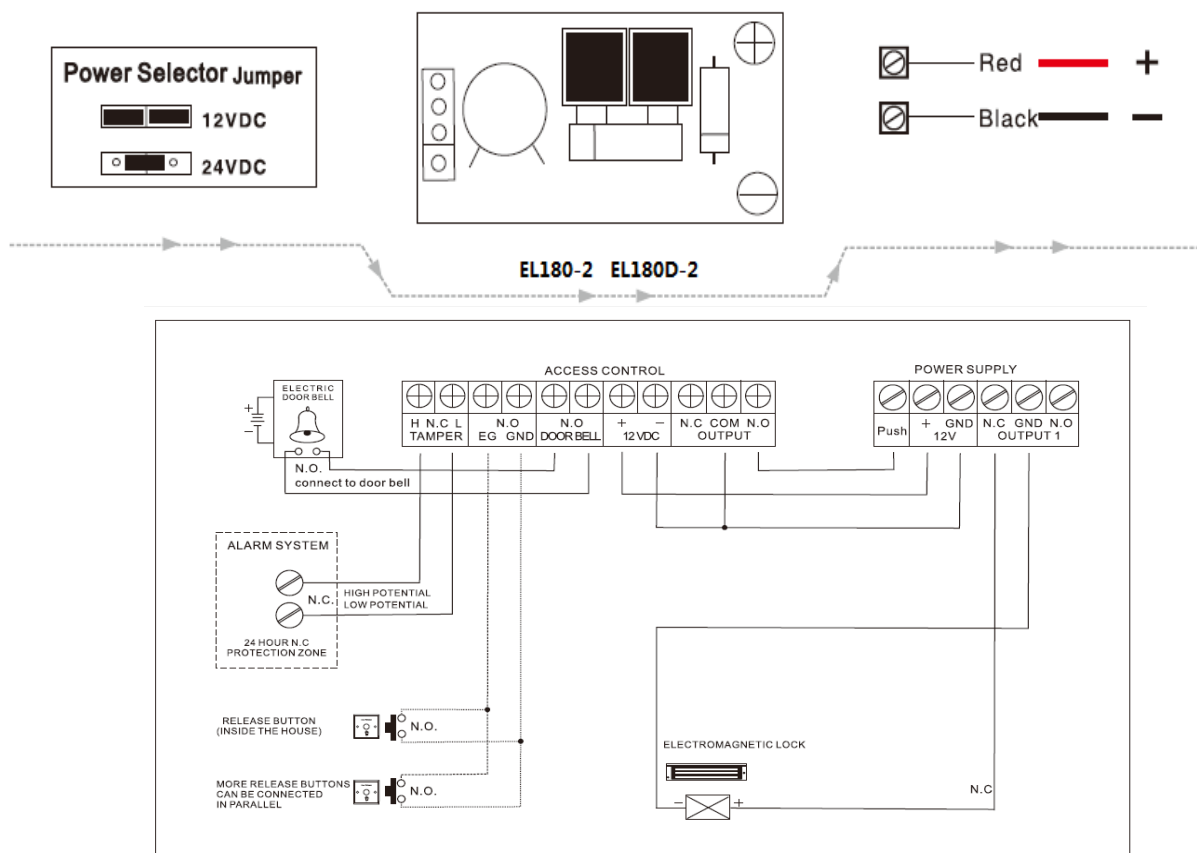

### NOTES:

Please read specification before installing magnetic lock

- Handle the equipment carefully. The holding force can be reduced by damaging the lock body or armature plate.
- The magnetic lock should be fixed tightly on the door frame and the armature plate on the door leaf. Kit provided allows the armature plate to pivot its center, thus compensating misalignment caused by other factors.
- Template can only be used with the door in normally closed circumstance.
- Please fix screws of magnetic lock firmly.
- Detect signal of door state: the limit of reed switch and dry contact is 0.5A/30VDC. Don't overload.